

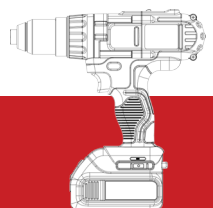

MOTORCYCLE & UNIVERSAL LOADERS

INSTALLATION GUIDE AC 004 tailgate adapter

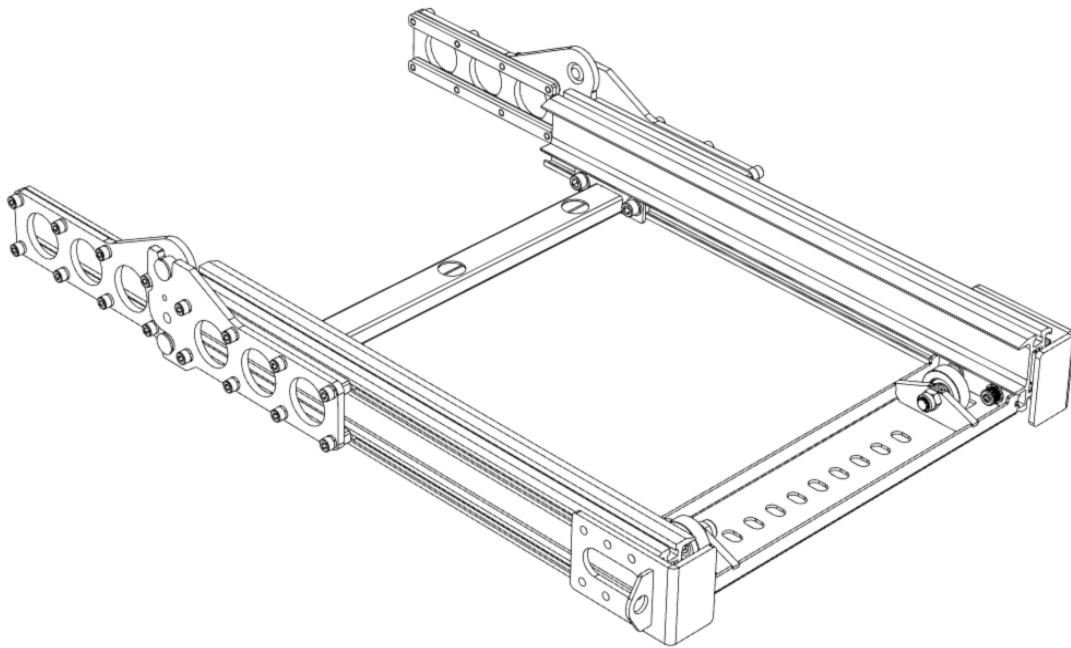

CORDLESS TOOL LIFT

PARTS SUPPLIED WITH AC 004 KIT	3
BEFORE INSTALLATION CHECKS	4
CUTTING BEAMS TO LENGTH	6
ASSEMBLING THE AC 004 UNIT	8
ATTACHING BRACKETS FOR THE MAIN RAMP	16
TIPS FOR OPERATION	26

AC 004 - TAILGATE ADAPTER

Rail locks, 2 sets

Quick release brackets, 2 sets

Stop brackets, 2 sets

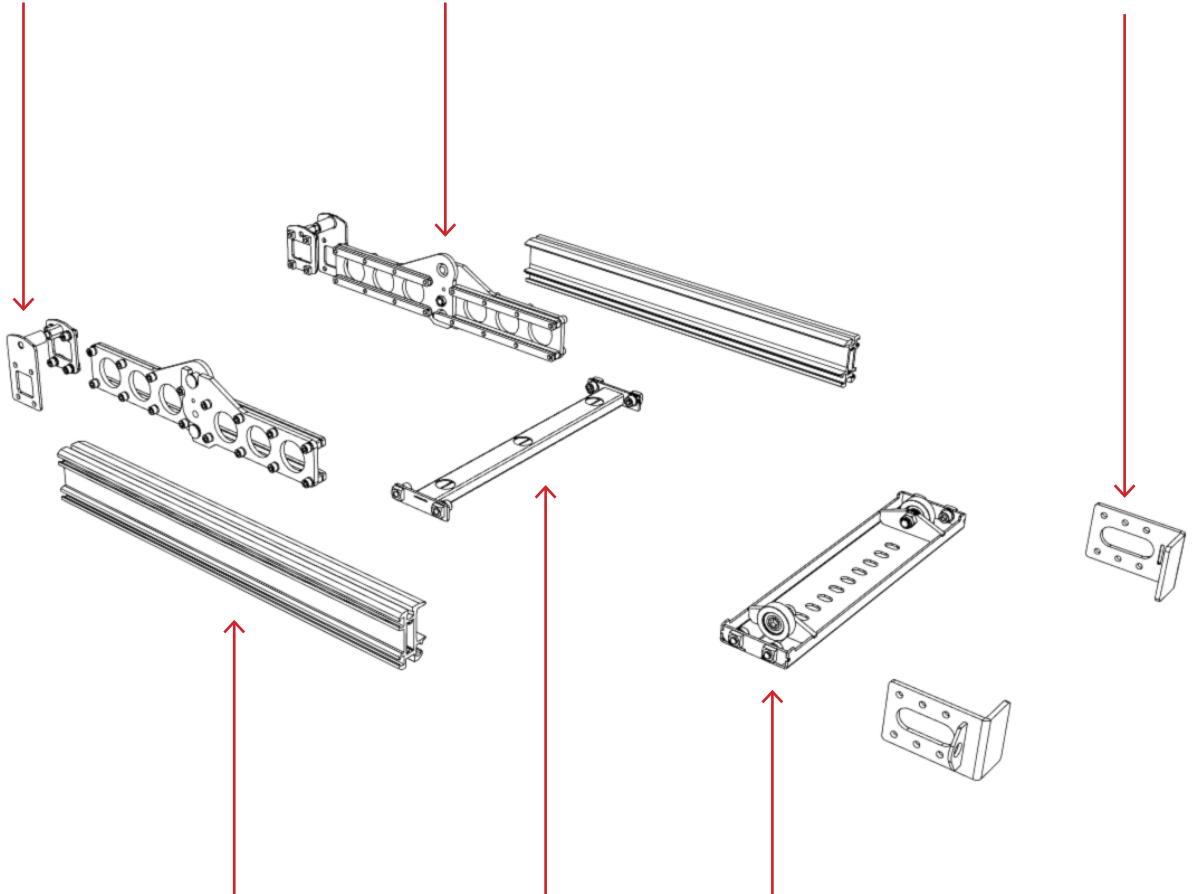

Aluminium rails, 2 PCS

Joiner

Roller bracket, 2 PCS rollers, nuts and bolts



There are two boxes, one for the steel parts, and one for the aluminum beams.

AC 004 - TAILGATE ADAPTER

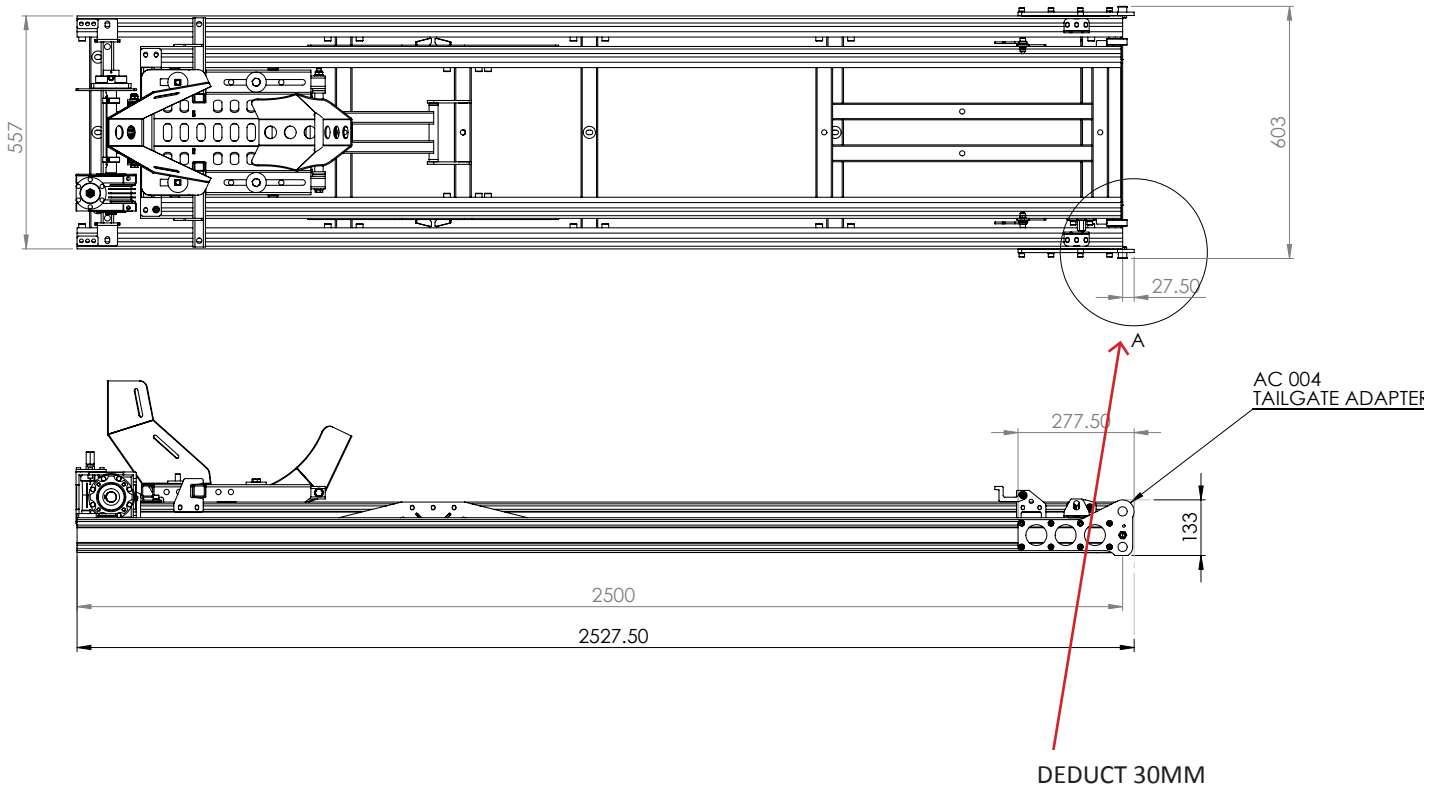

NOTES

Some clients will need to cut the original beams so that the ramp fits in the cargo bed when the tailgate is closed. Note that when the AC 004 quick release brackets are attached, the ramp becomes 30mm longer. So when you cut the beams, make sure you allow for this (cut 30mm shorter than the length of cargo bed with the tailgate closed).

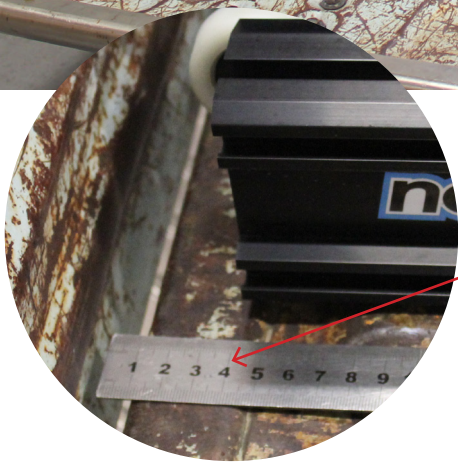

30 - 40mm gap

NOTES

Example - in the picture above, ramp beams are cut to leave a 30-40mm gap between the rear of the ramp and the tailgate in closed position. Better to cut 40mm shorter (1 1/2") to have some wiggle room.

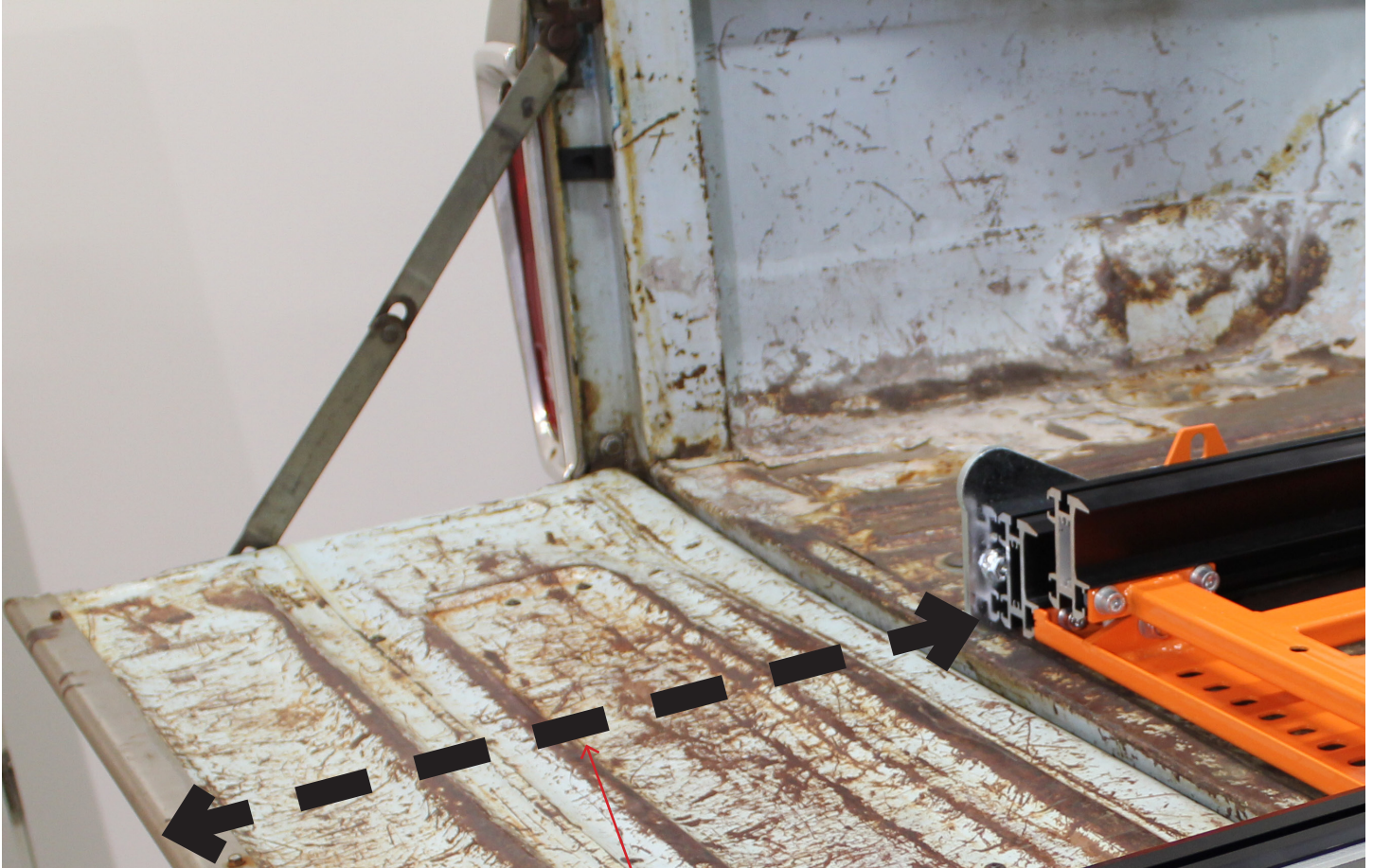

Measure this distance

NOTES

Place the ramp in the truck precisely where you want it to sit. Measure the distance from the end of the aluminum beams to the edge of the tailgate when the tailgate is down. This will give you the length of the aluminum beams needed for your AC 004.



Cut beams together in one go

NOTES

The two beams should be exactly the same length. Place them together and cut them with a bench mounted circular saw using a blade with at least 90 teeth (fine teeth, there are standard cutting blades with fine teeth).

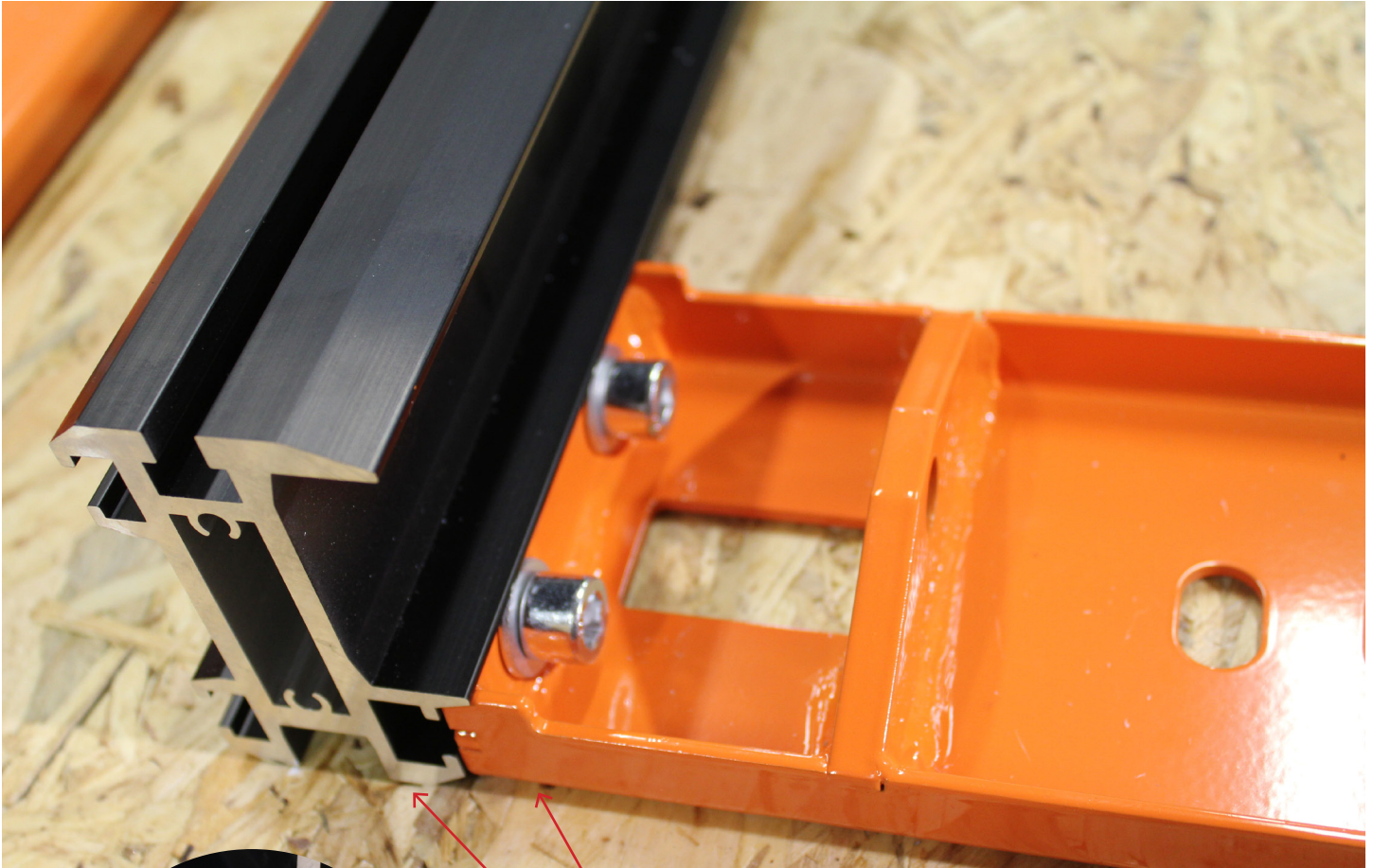

Bracket flush with beams

NOTES

Remove the two rollers from the roller bracket. Loosen the square nuts so that the bracket can slide through the bottom groove of the aluminum beams. Make sure the rear edge of the bracket is flush with the edge of the beam. Do the same on the other side.

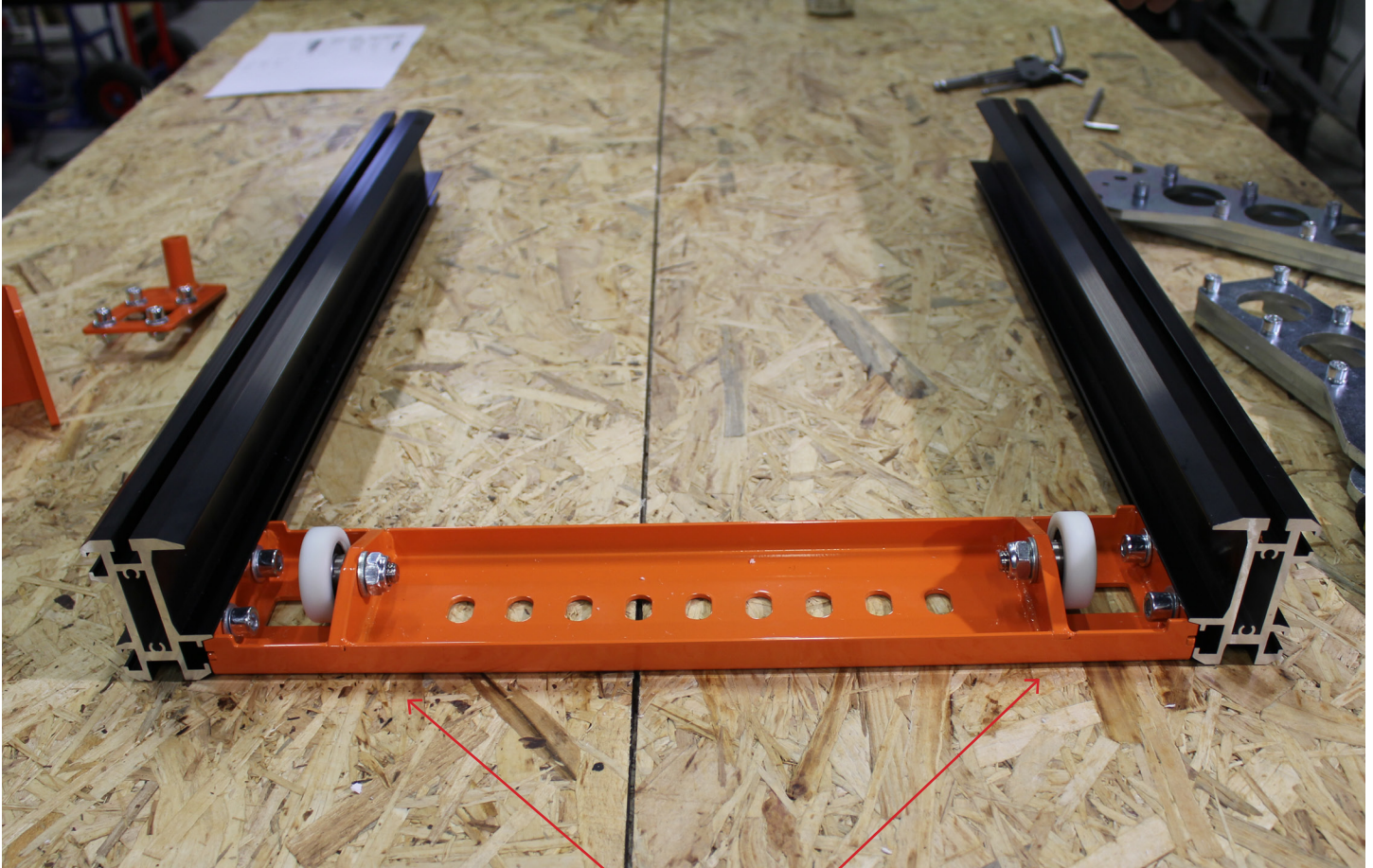

Attach the rollers

NOTES

Attach the rollers. The flat washer to be placed on the nut side.

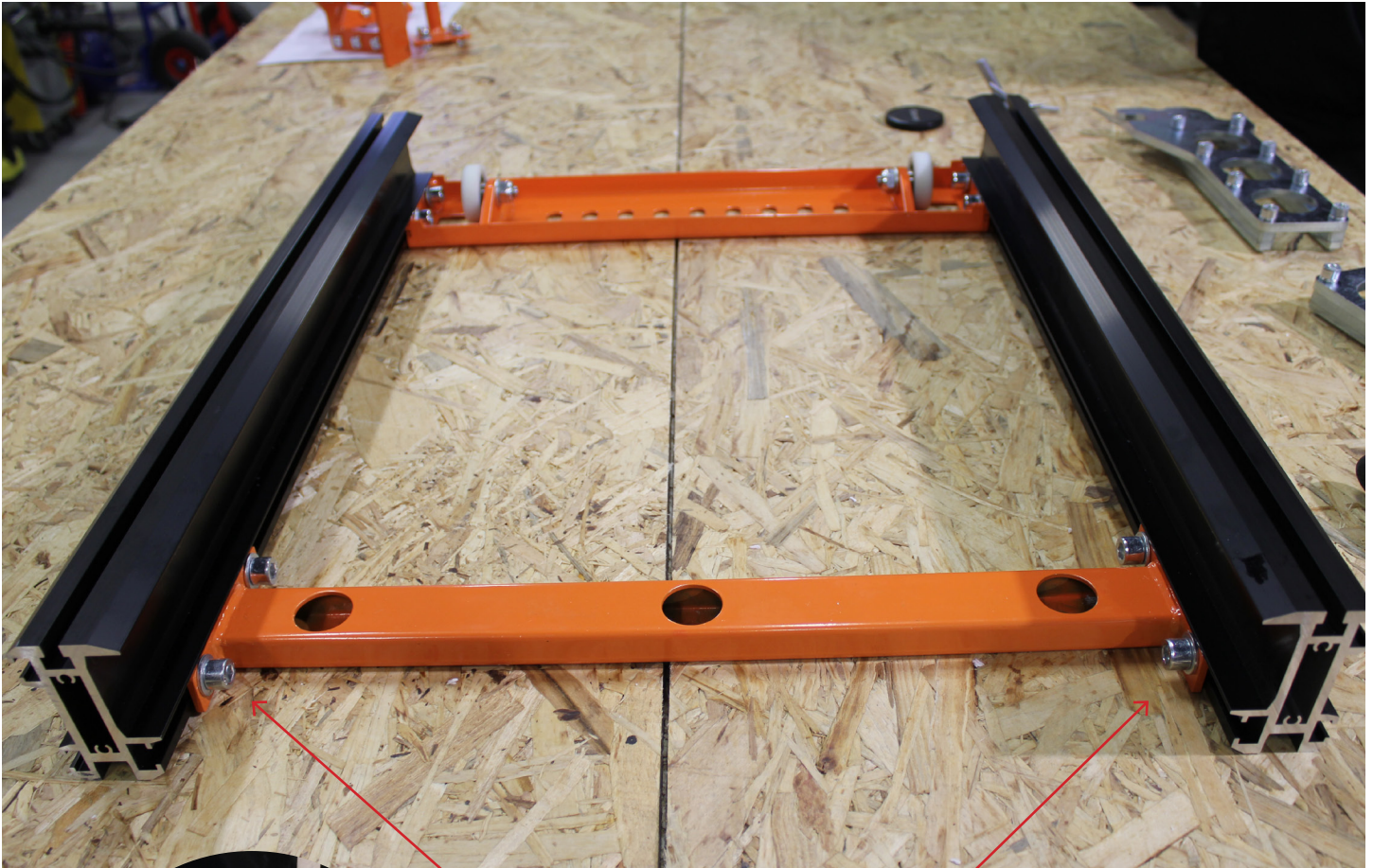

Attach the joiner

NOTES

Same procedure as the roller bracket - loosen the nuts somehow, so they can slide through the grooves. Position the joiner around 50mm behind the front edge of the beams. This dimension does not need to be precise.

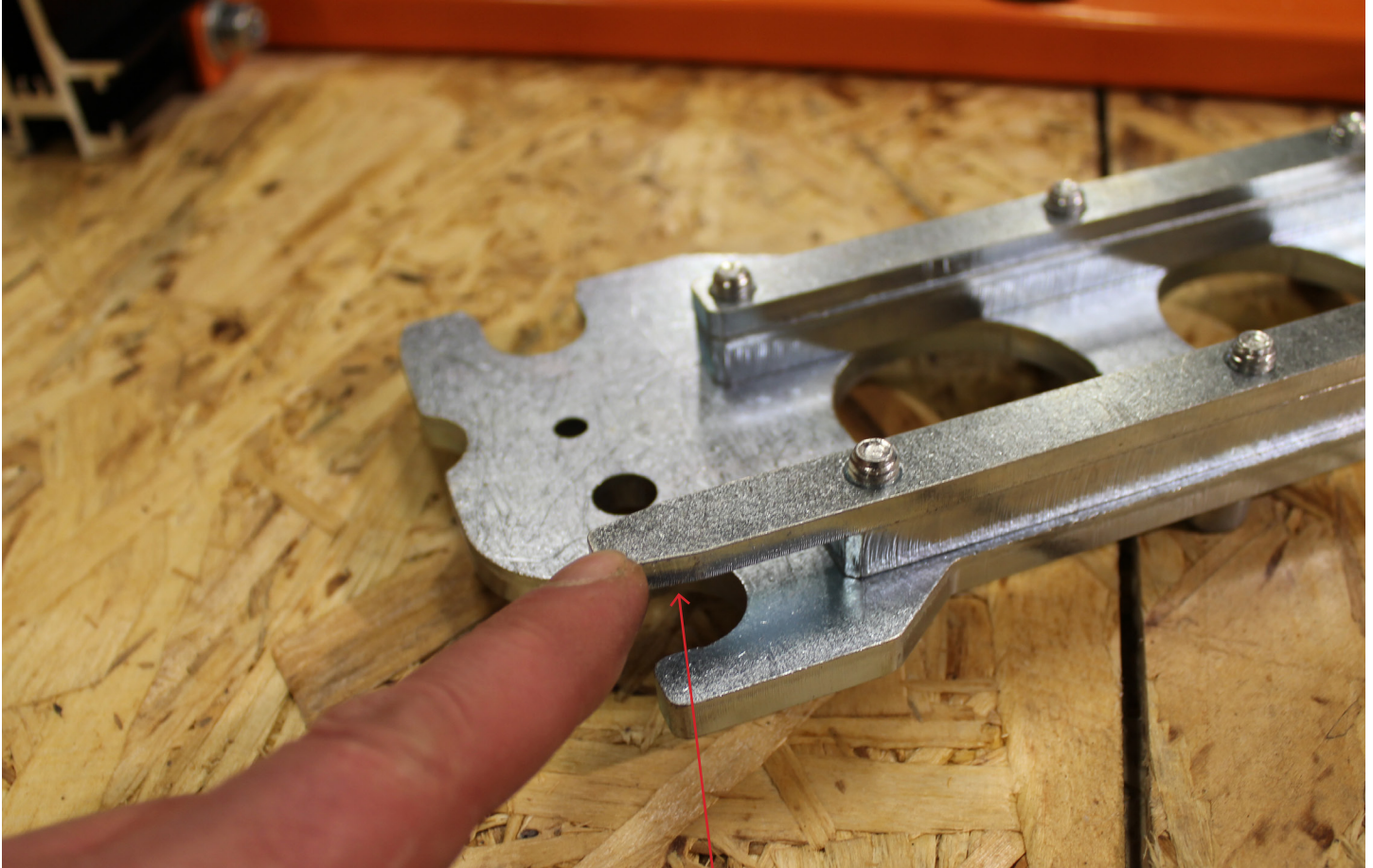

Metal prong

NOTES

Grab a quick release bracket, the one with the metal prong sticking out.

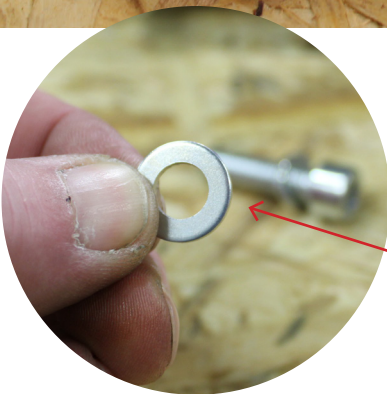

Add flat washer

Loosen the bolts

NOTES

Loosen the bolts on it so it can slide through the aluminum rail. Please note, in the first series manufactured these brackets were delivered with spring washers only. Add one flat washer to each bolt. Flat washer to sit against the plate, and the spring washer against the bolt.

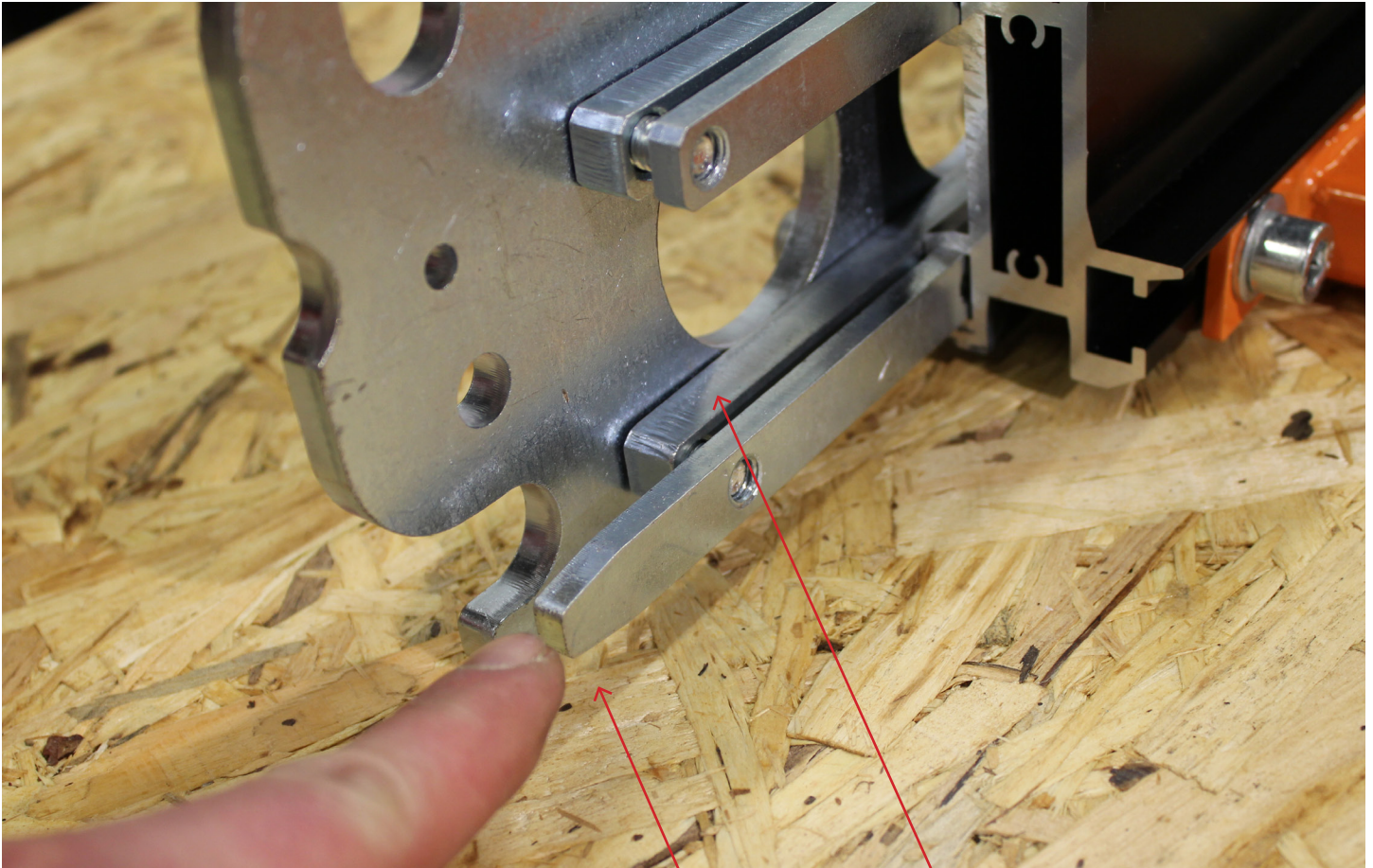

Metal prong

Steel spacer

NOTES

Slide the bracket through the rail, with the metal prong down. The steel spacers to sit between the rail and the bracket.

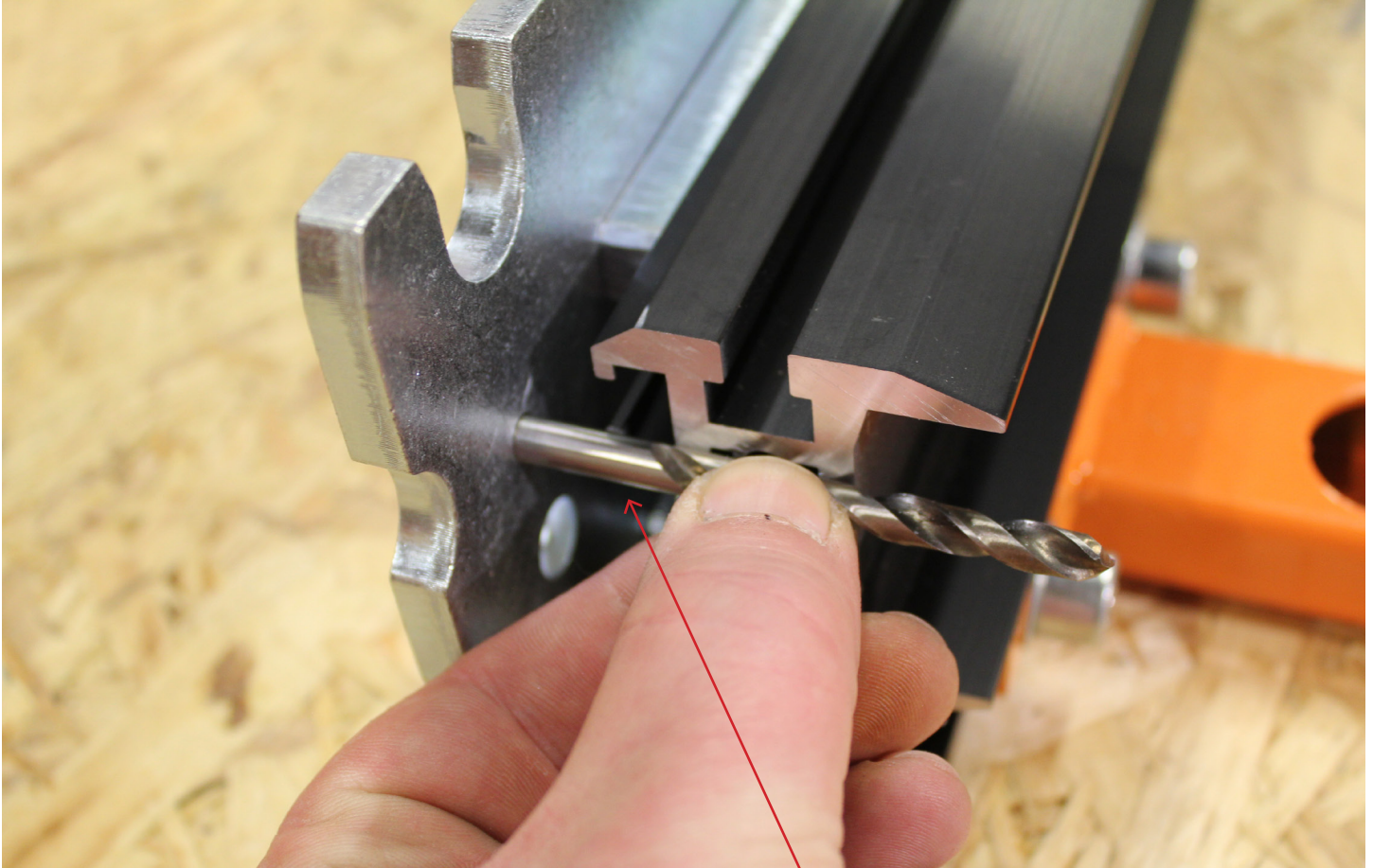

Add flat washer

6mm drill bit

NOTES

Insert a 6mm drill bit through the 6mm hole in the pronged bracket. Slide the bracket through the aluminum rail until the 6mm drill bit sits flush across the face of the aluminium beam. Tighten the bolts. Repeat on the other side of the AC 004 adapter.

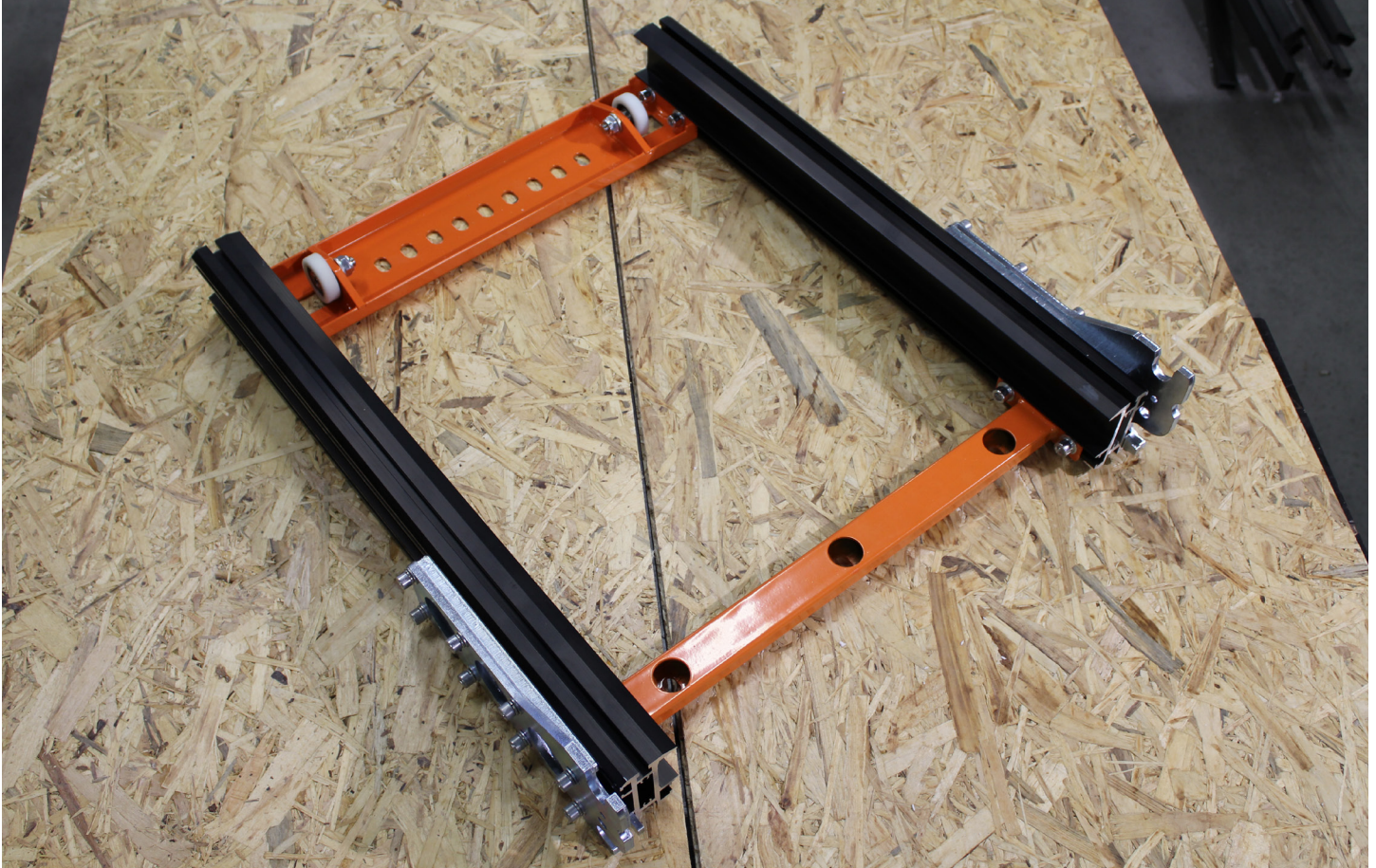

NOTES

Check all parts and bolts. AC 004 adapter should now look like in the attached picture.



Remove brackets and rollers

NOTES

Remove the lock brackets and end rollers from the ramp. Loosen their bolts and slide them out.



Remove the stoppers

NOTES

Remove the stoppers on the rear end of the ramp on both sides.



Four notches

NOTES

Grab the two lock brackets supplied with the AC 004 kit. Note, they have four notches cut at the bottom.

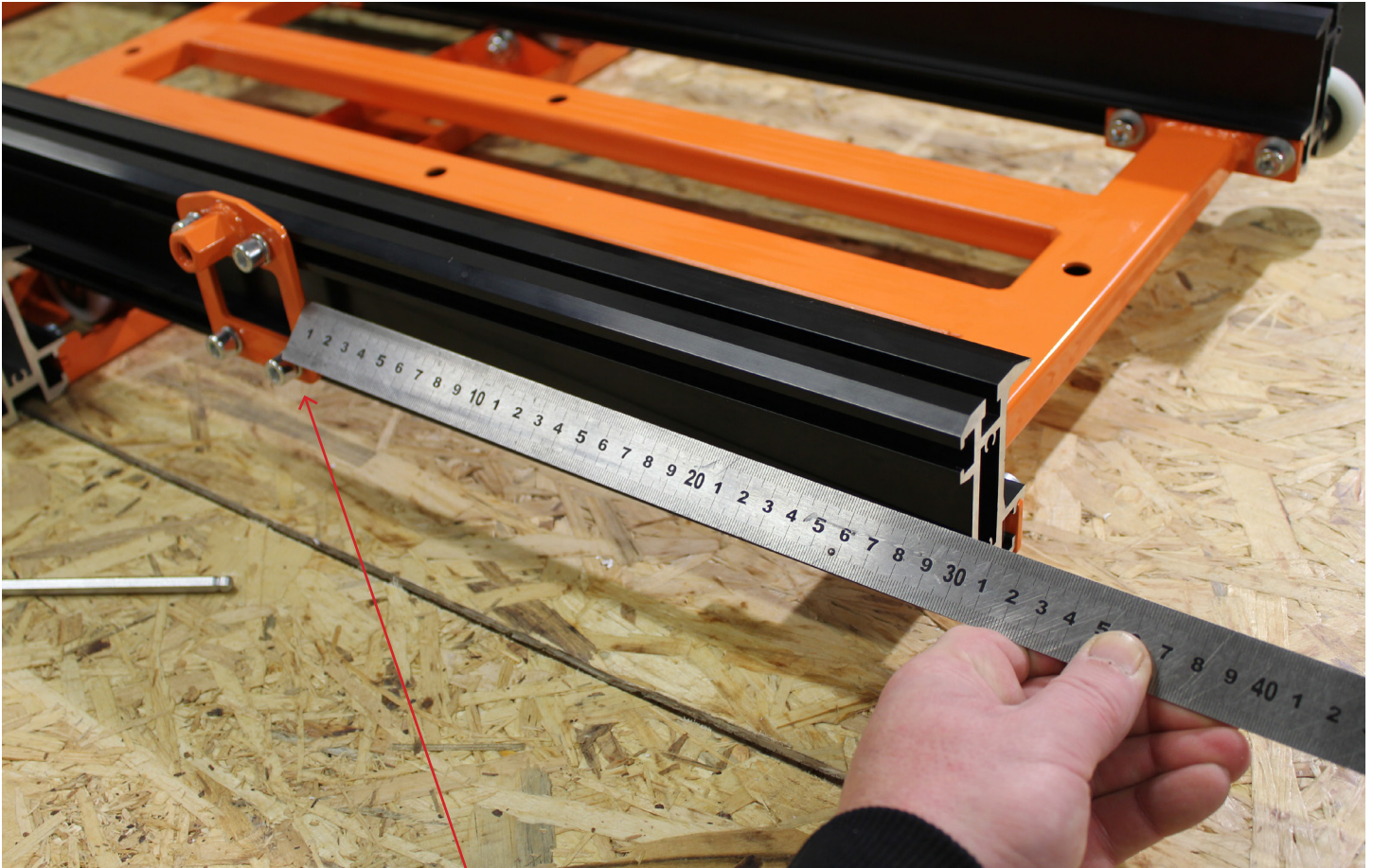

Attach AC 004 locks

NOTES

Slide the AC 004 lock brackets into the grooves of the tilt frame aluminum beams. Lock them in at minimum 300mm distance from the rear edge of the tilt ramp.



Matching lock bracket

NOTES

Slide the matching bracket for the locks through the grooves of the main ramp aluminum beams until it lines up with the lock bracket already secured to the tilt frame beams. Use the 60mm long M10 knob to make sure they are lined up. Tighten the bolts.

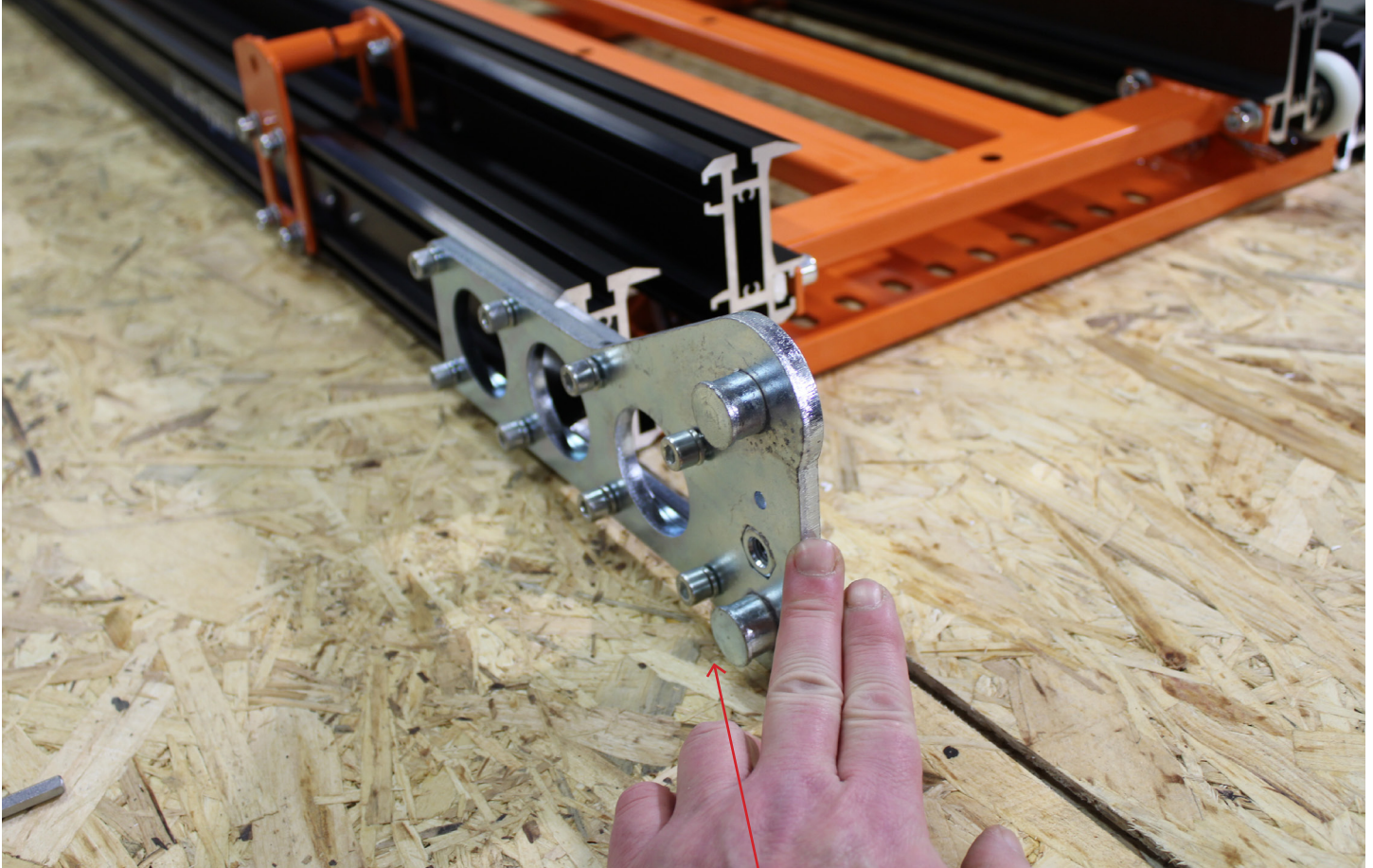

Attach main frame brackets

NOTES

With the lock brackets aligned like in the attached picture, slide the main frame quick release brackets through the grooves of the main frame. Please note the spacer plate positioning on the next page.

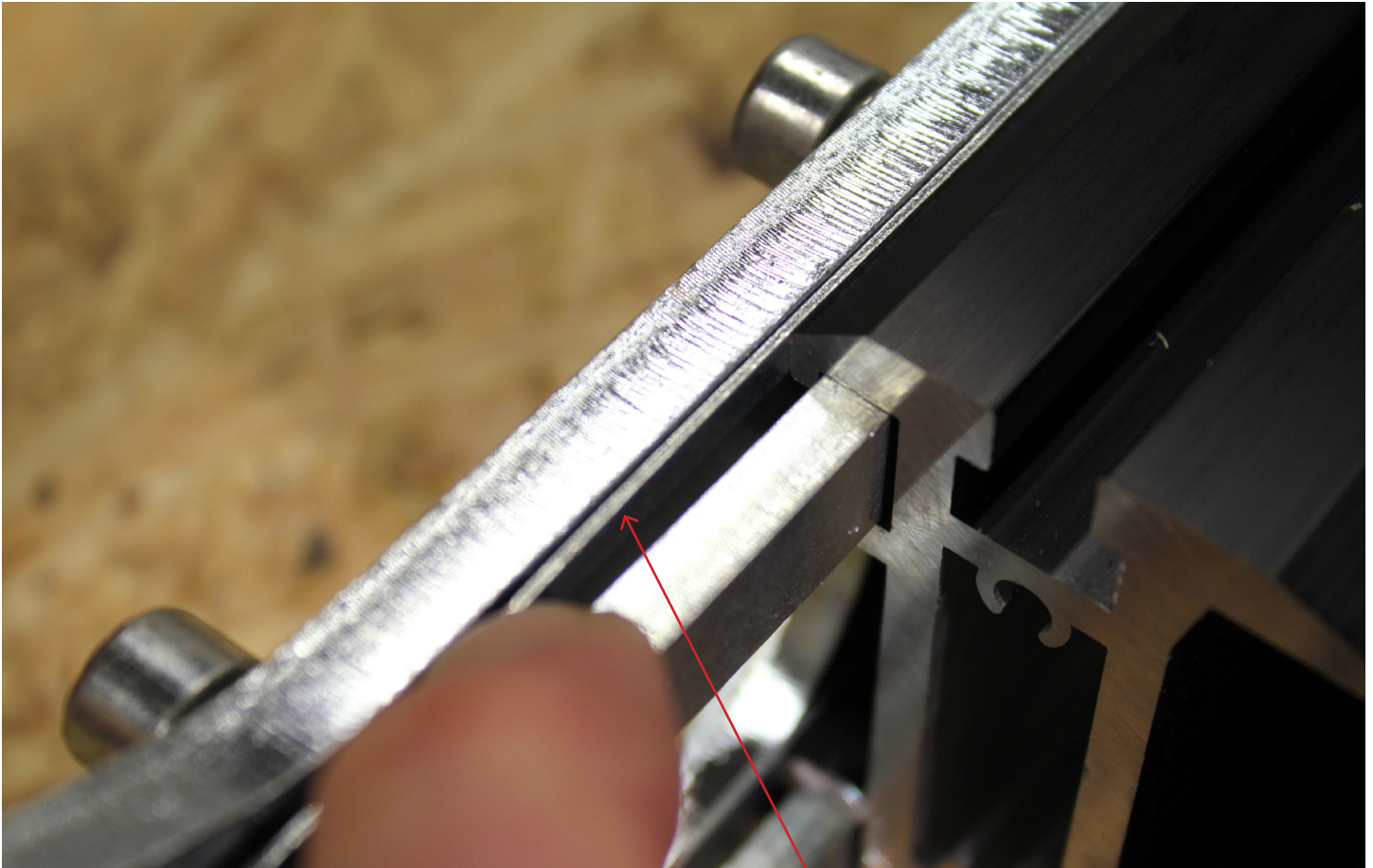

Thin spacer plates

NOTES

The thin spacer plates to sit between the aluminum beams and the bracket, both top and bottom.



Align bracket and lock it in

NOTES

Use a 6mm drill bit to align the bracket with the face of the aluminum beam.

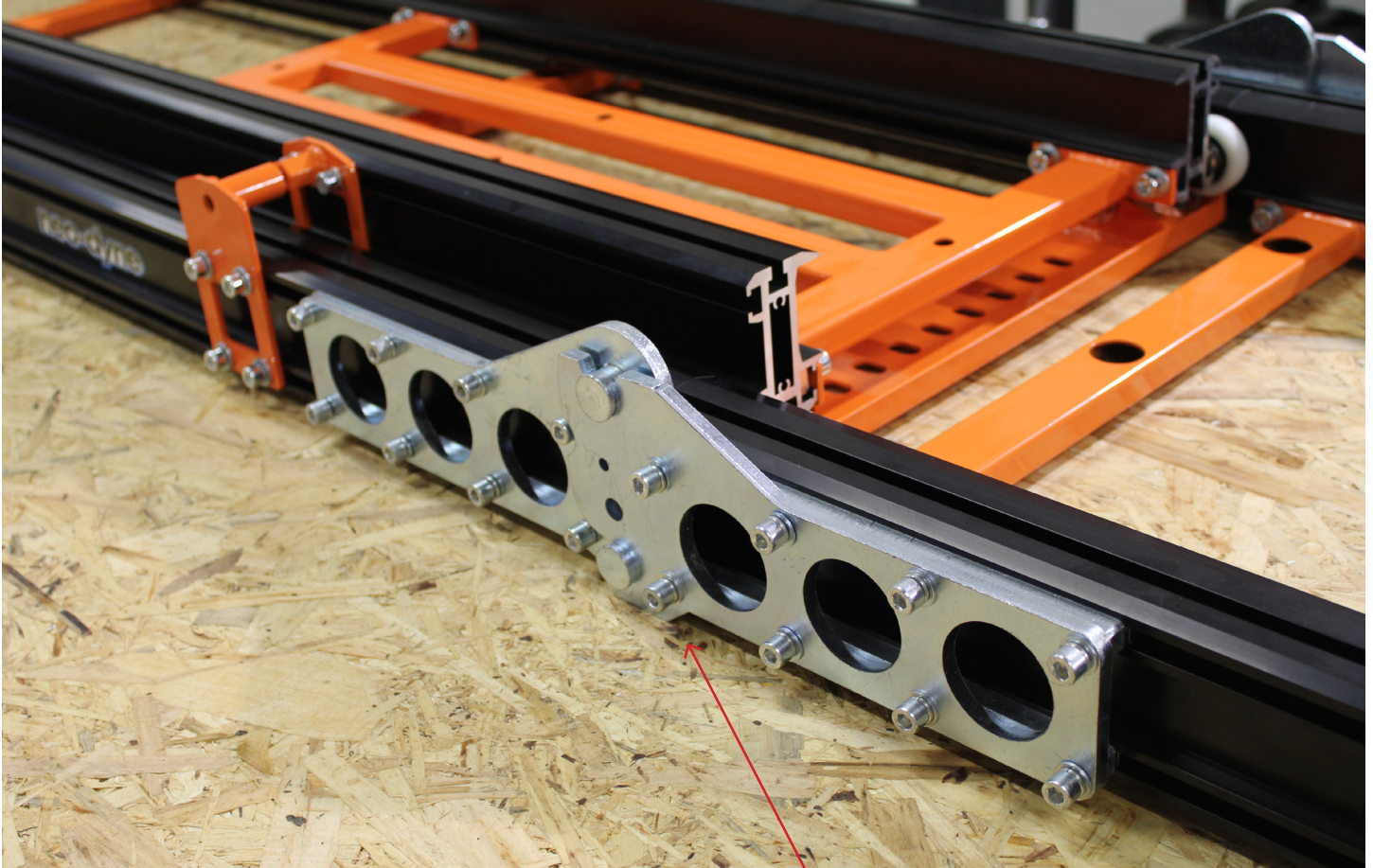

Lock check

NOTES

Lock the AC 004 to the ramp and check the gaps between the ramp rails and the AC 004 rails. A small gap around 1mm is alright.

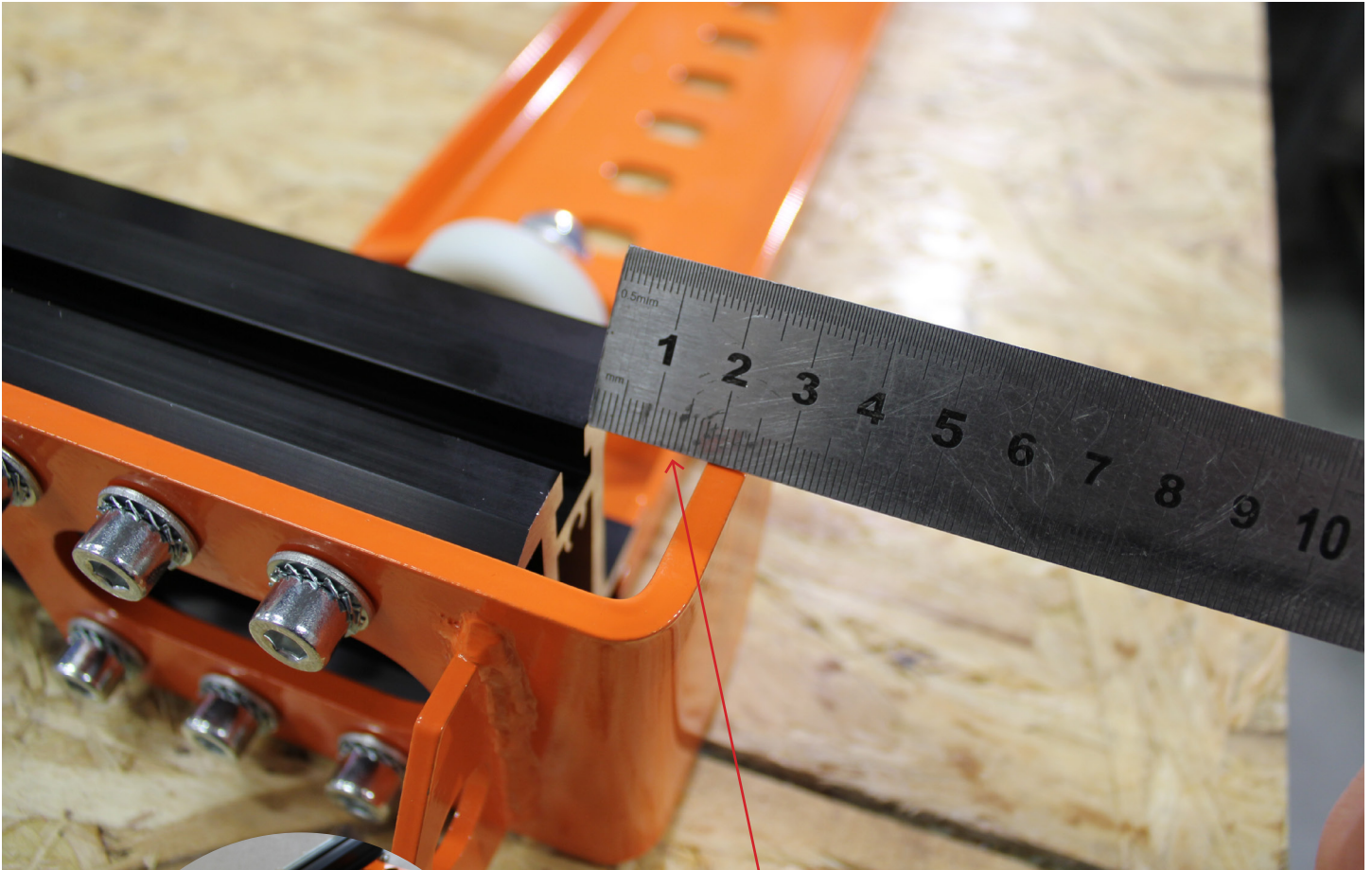

19mm (3/4")

NOTES

Slide the stop brackets through the rear end of the AC 004 adapter. Keep a 19mm or 3/4" space between the inside of the bracket and the edge of the aluminum beam.

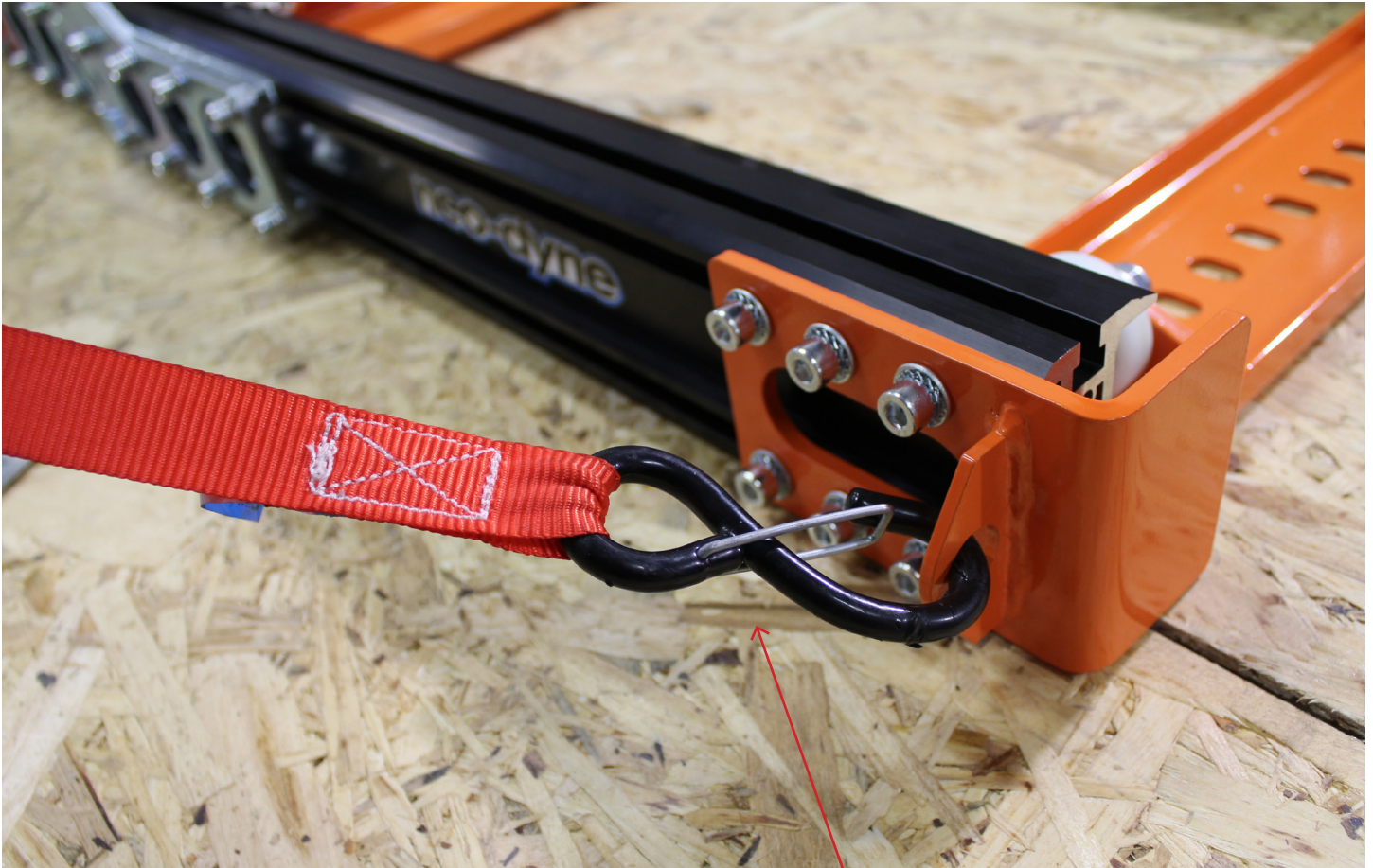

Extra support

NOTES

For extra support, you can attach a strap from the stop bracket and to a hardpoint in the vehicle, such as a tailgate lock bar or other hardpoint.

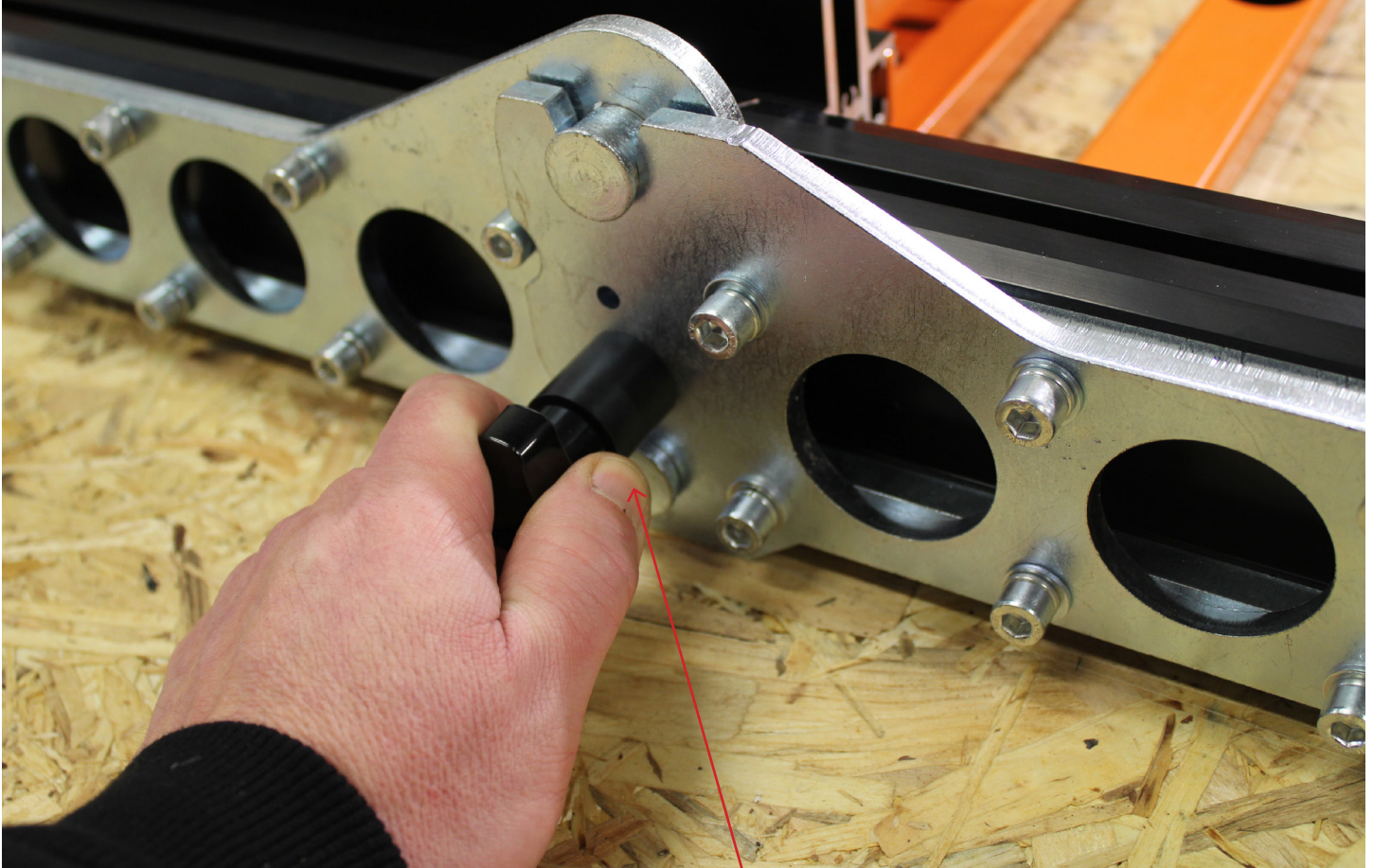

Original lock knobs

NOTES

Use the original lock knobs supplied with the main ramp to lock the AC 004 brackets during use.

DO NOT OPERATE THE RAMP WITHOUT THE AC 004 ATTACHED !